

## EverBlu / RF option board for Ultrasonic meters

### Mounting and operations instructions

#### 1. Scope of delivery

- EverBlu / RF option board
- EverBlu/ RF option board battery pack (option for battery powered meter)
- Installation guide

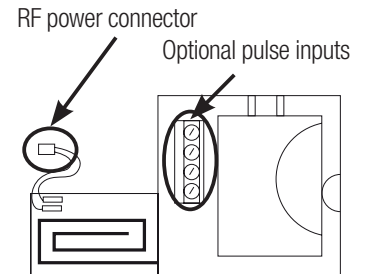

#### 2. General description

The EverBlu / RF option board is designed as interface between the CF- meter family and the Itron RF system.

Itron offers a complete Data Collecting System including hand held terminals, RF interfaces, reading- and route-management software as well as RF software drivers. The option board is powered by an independent battery pack not to influence the meter lifetime. Optionally two pulse collecting registers are available for connection of two external water meter with pulse outputs.

#### 3. Safety instructions

Special care must then be taken to respect the installation procedure described in this document to protect your safety, ensure the proper measuring performance and comply with guarantee terms.

Always operate your EverBlu / RF option board for the use it has been designed for.



##### 3.1 Signs used in this document

WARNING: this sign indicates potential electrical hazards



This sign indicates a continuous current



CAUTION: this sign indicates potential hazards



##### 3.2 Safety

Water networks and main power supplies may operate at high pressures and high voltages that may cause severe physical injuries. Only qualified professionals familiar with involved hazards should be permitted to open the energy integrator housing and install the flow meter.



Make sure your network pipe is connected to the earth.

Always switch off main power supply prior to opening the energy integrator.

#### 4. Technical data

Power supply	:	2 x 3,6V lithium-batteries
Battery typical lifetime	:	max. 12 years *

\* under normal applications with monthly reading cycle and within the specified operating temperatures.

#### 4.1 Operating Temperature Conditions

4 months/year : +30°C...+55°C max.

with : 6 h/day max +55°C or 6 h/day min < +35°C

Average temperature for 24h : < +40°C

Rest of the year max. +35°C

#### 4.2 Storage Temperature

+5°C to +35°C

#### 4.3 Transport Temperature

Min. -20°C (<72 hours continuous)

Max. +70°C (<72 hours continuous)

#### 4.4 Environmental Conditions

No direct sunlight exposition.

Relative humidity < 95%.



#### 5. Radio frequency features

Protocol	:	MFD protocol according to Radian user organisation
Conformity	:	Compliant with the European R&TTE directive 1999/5/EC
Modulation	:	Frequency Shift Keying
Frequency carrier	:	433,82 MHz
Radiated power	:	< 10 mW
Transmission	:	Symmetrical 2-way communication

#### 6. RF reading system

The EverBlu / RF option is part of the Itron system for mobile meter reading.

To setup the EverBlu / RF option board and to integrate the meter into the mobile reading system, the RFCT software tool is mandatory.

The tool is available for PC or for the Itron hand held terminal.

Please refer to the corresponding programming guide and software usermanual for detailed information.

#### 7. CE declaration of Conformity

Hereby, the Itron company declares under its own responsibility that the above described product is in conformity with essential applicable requirements and in particular with the following on the directives 1999/5/CE:

Article 3.1 a:	(protection of the health and the safety of the user),
Article 3.1 b:	(protection requirements with respect to electromagnetic compatibility),
Article 3.2 :	(effective use of the spectrum allocated to terrestrial/space radio communication and orbital resources so as to avoid harmful interference).

To that end, the Itron company declares that the essential radio tests suites have been carried out.

Applied procedure: Annex III of the directive 1999/5/CE.

Mâcon, December the 10th, 2009

9, rue Ampère

71031 Mâcon cedex

Nathalie Vossion

Quality Manager

## 8. Installation of the EverBlu / RF option board

### 8.1 Open calculator

Open the meter case by unscrewing the side screws.

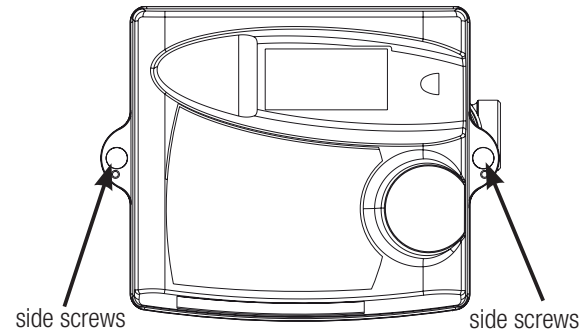

### 8.2 Dismounting the existing CF calculator power supply

Dismount any existing battery pack by releasing the plastic lock at the lower part of the casing.



ATTENTION:

Remove any 2AA battery pack. Only use the size C battery pack supply for the meter. The size C battery is not included in delivery of the RF option board. In case the meter is not fitted with a size C battery it must be ordered separately.



ATTENTION:

Always use the battery specifically designed for EverBlu / RF Option Board. Do not recharge, disassemble, heat above 100°C, incinerate, or expose contents to water. Dispose in a special bin.

### 8.3 Mounting the EverBlu / RF option battery pack

Place the RF option battery pack in the space below the original meter power supply. Pass the battery pack cable in-between the feedthrough of the plastic lock.

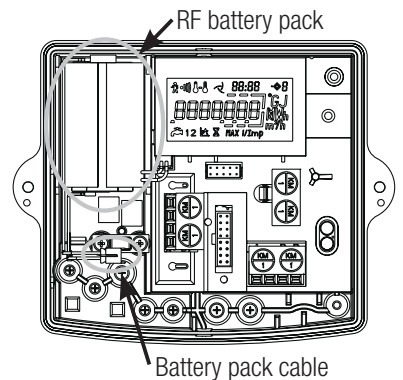
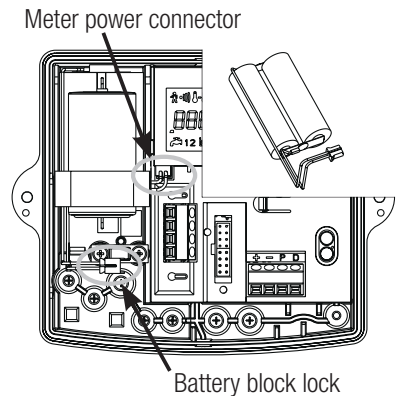

### 8.4 Mounting the meter battery pack



ATTENTION:

Before re-installing any size C battery pack please carefully remove the plastic cable tie wrapped if exists around the battery board.

Locate the size C battery pack of the meter at the original position. Lock the pack with a click.

Take care to re-connect properly the cable to the meter power connector.

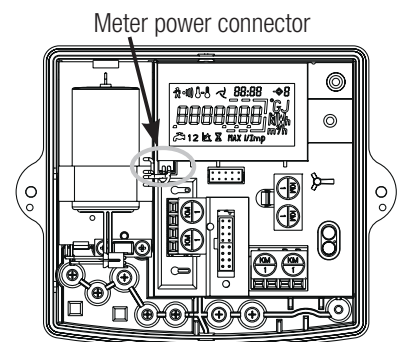

### 8.5 Mounting the EverBlu / RF option board

Plug the option board using the guidance clip on the right hand side of the calculator pushing then the board until all option board connections are made.

Connect the RF battery cable to the power connector of the option board.



ATTENTION :

Avoid ElectroStatic Discharges by NOT touching any electronic components.

Only manipulate the product by the side of the board and plug it pushing on the metallic lid.

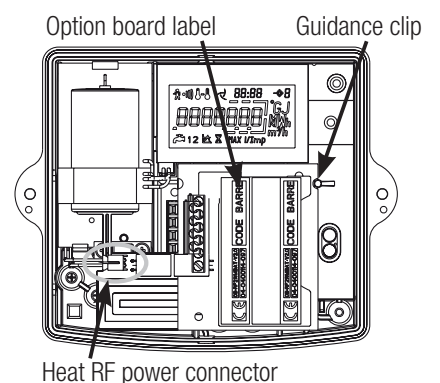

## 8.6. Labelling

Place the unstickable label with RF reference number at the free labelling area at the bottom front side of the calculator case.

## 8.7. Optional Water Meter configuration

In case of the use of Optional Water Meter outputs configure as described in Chapter 9.

## 8.8. Closing calculator

Close the calculator carefully with the side screws.

## 9. Optional watermeter inputs

### 9.1 Input characteristics

- Accept pulse	:	from dry contact, open collector, open drain or static relay
- Maximum frequency	:	10Hz
- Minimum low state	:	100ms
- Maximum on resistance:	:	10k $\Omega$
- Opto-isolation	:	No
- Cable length	:	<10m
- Cable diameter	:	3,5mm ... 6,5mm
- Wire size	:	0.2mm <sup>2</sup> ... 1,5mm <sup>2</sup>

### 9.2 Setup of the water meter registers

For programming the water meter registers with pulse value and meter offset use the pushbottom [A] and [B] as follows:

1. After plugging the option board, push button (B) in order to launch the option board installation procedure.  
Wait until the option board is recognized, the first screen related to this option board will then be displayed showing related settable digits flashing.
2. To change the pulse value or the meter offset navigate to the corresponding loop in the meters display. The registers can be easily identified in the display by the water tap icons.
3. Once the desired register is visualized, activate the programming mode by pushing [B] for approx. 2 sec.
4. The flashing digit can be edited by pushing [A].
5. To confirm the edited value and to proceed to the next digit push [B].
6. By pushing [B] for approx. 2 sec. the programming mode is closed and values are programmed.

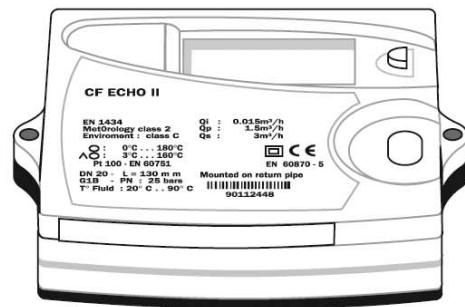

Label area

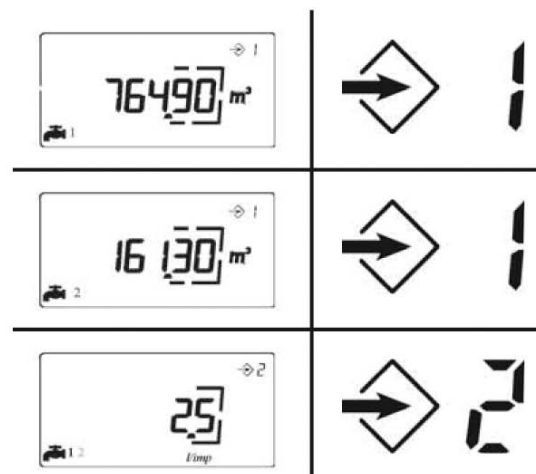
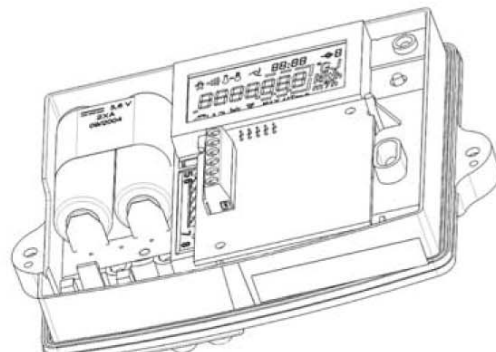

**Itron**

Allmess GmbH  
Am Voßberg 11  
23758 Oldenburg i.H.  
Germany  
[www.itron.com/de](http://www.itron.com/de)